

Montsaye  ACADEMY
Excellence Resilience Aspiration

YEAR 8
Homework Booklet
Perspective

Boxes in Perspective

Connect the corners of the boxes to the vanishing point.
Draw the sides of the boxes with horizontal and vertical lines.
Erase the rest of the lines to the vanishing point.

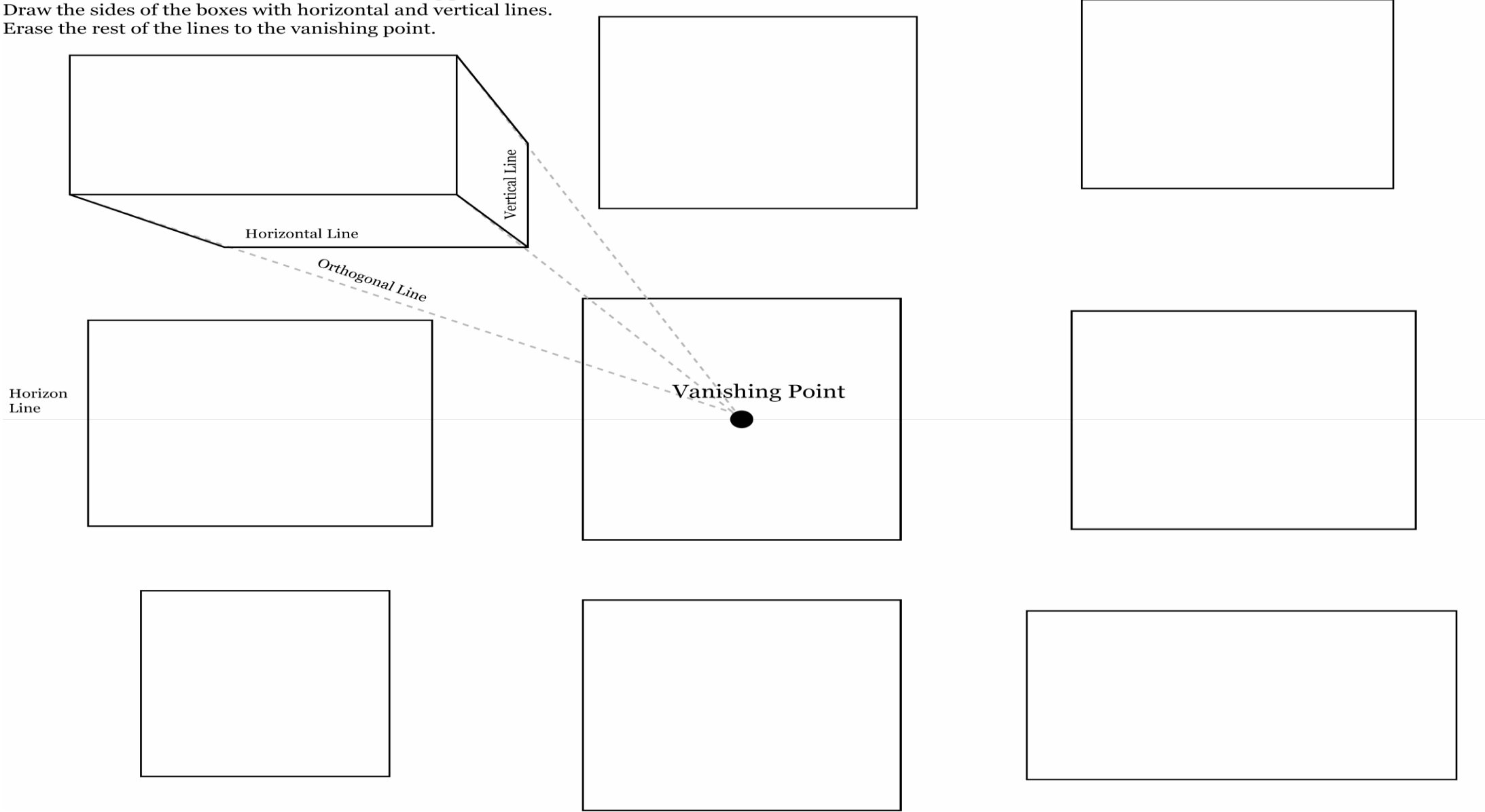

Letters in Perspective

Connect the corners of the letters to the vanishing point by each letter.
Draw the sides of the letters with horizontal and vertical lines.
Erase the rest of the lines to the vanishing point.

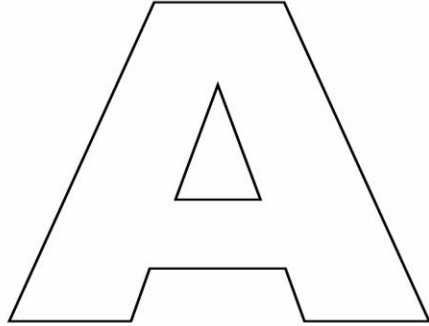

● Vanishing Point A

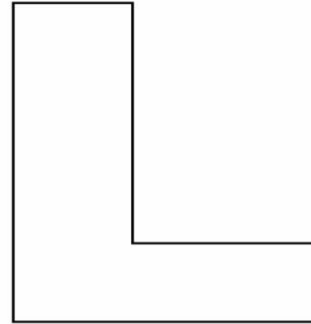

● Vanishing Point L

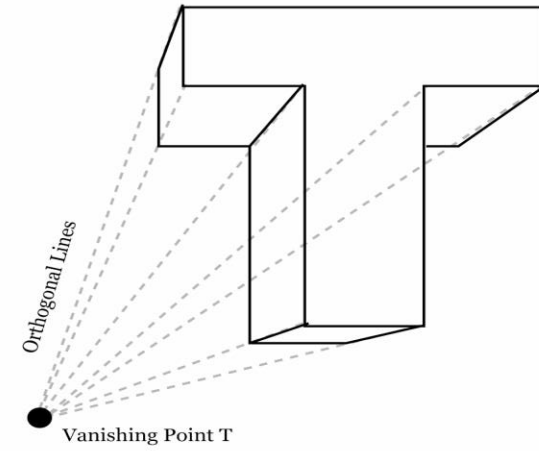

● Vanishing Point W

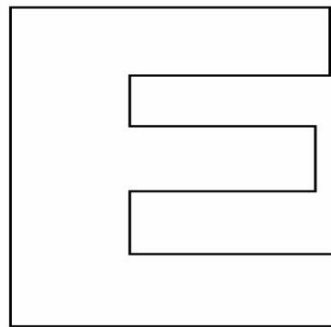

● Vanishing Point E

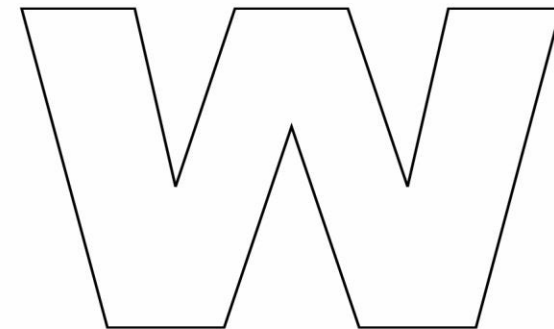

Real World Objects in Perspective

Connect the corners of the objects to the vanishing point.
Draw the sides of the objects with parallel lines.
Erase the rest of the lines to the vanishing point.

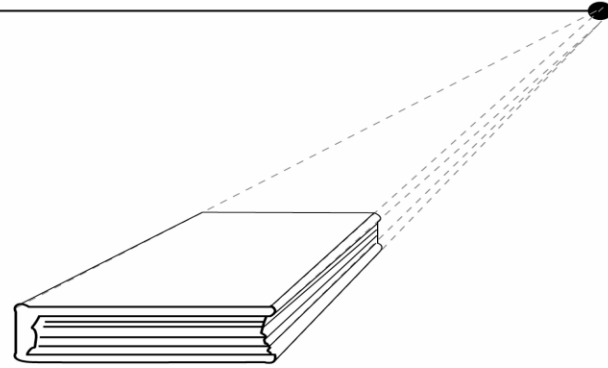
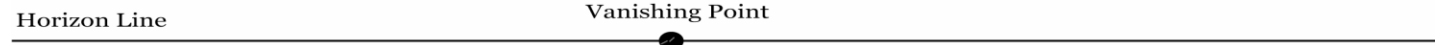

Book

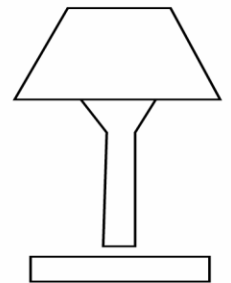

Lamp

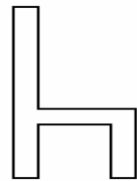

Chair

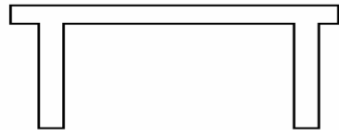

Table

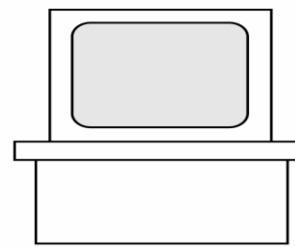

TV

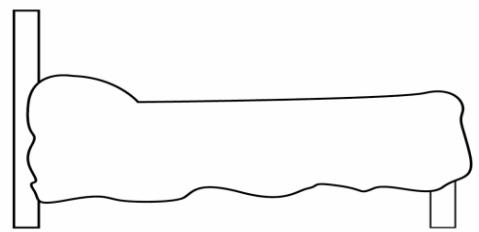

Bed

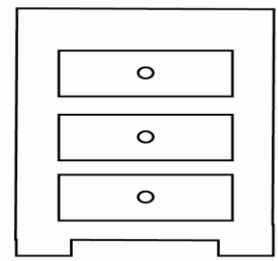

Chest